

CUSTOMER TERMINAL	ROHS	Lead(Pb)-free
	YES	YES

1. Mechanical Dimensions

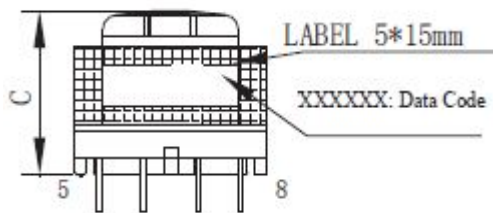
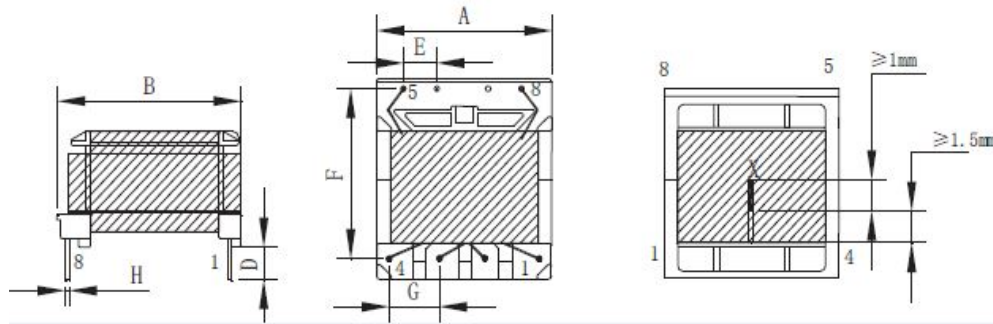

A	21.0	MAX
B	23.0	MAX
C	18.0	MAX
D	3.5	±0.5
E	4.0	±0.3
F	18.2	±0.4
G	5.0	±0.3
H	0.80	±0.1

2. Schematic Diagram

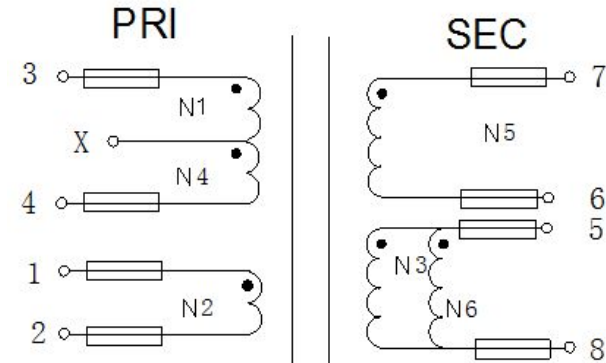

3. Material List

Core:FW44 EE20/20/6
 Bobbin:FWB2010(4+4PIN)
 Wire:2UEW TIW
 Operating Temperature: -30 to115 °C

4. Electrical Specification

Inductance : $L(3-4):4.1\text{mH}\pm 5\%$ 10KHZ , 0.25V
 Leakage Inductance : 95uH MAX 10KHZ , 0.25V
 DCR : (6-8)=0.12Ω MAX (3-4)=6.0Ω MAX
 Hi-Pot:P-S: AC 60Hz 4000V 1mA 3S

REV.	DATE	 Convention Placement	DRW.	Drawing Title:	Part No:		
0	00/00		CHK.			TRANSFORMER	FWPTEF20H412J-1
			APP.			Customer P/N	Specification Sheet 1of 1
ROHS		www.ferriwo.com					